



PREFORMED LINE PRODUCTS

Section 12 – Buried Service Wire Closures

Table of Contents

Ranger SERVICEAL® Closure	12-2
Super SERVICEAL® Closure	12-3
BLACK-JACK™ Closures.....	12-4



Ranger SERVICEAL® Closure



Enhanced!

The Enhanced Ranger SERVICEAL Closure provides long-term protection for buried service wire splices up to six pairs (0.500" [13mm] cable diameter).

Installation of the Ranger SERVICEAL Closure is fast and easy. After preparing the service wires, simply lay them within the grooves in the cap, lay the exposed cable shield within the Bonding Connector and tighten. Splices on the individual pairs are easily organized around the integral Insertion Ram. A twist and a snap secures the pre-filled vial over the splices.

Features:

- Only two components, pre-filled vial and cap with integral Insertion Ram and Bonding Connector
- Vial pre-filled with field proven POLY-BEE™ Sealant for maximum protection
- Octagon shaped Vial for ease of application and maximum splicing capacity
- Enhanced, integral Bonding Connector
- Positive locking feature to insure proper application and to discourage re-use

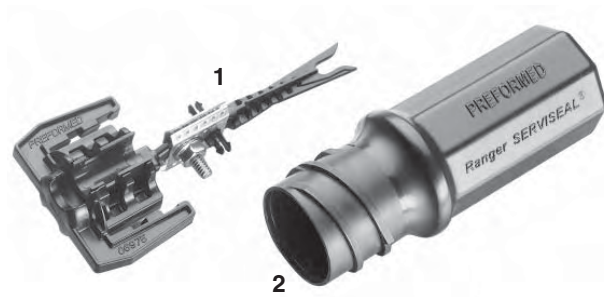

Kit Components

1. Cap with integral Insertion Ram & Bonding Connector
2. Sealant-filled vial

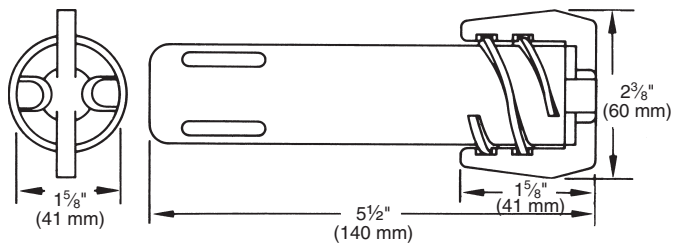

RUS Listed

Catalog Number	Groove Diameter	Standard Carton Qty.
8006137	Up to .500" (13 mm)	12 Kits

Catalog Number	Description	Standard Carton Qty.
8008946	Vial Replacement Kit	As needed

Super SERVICEAL® Closure



Enhanced!

The enhanced Super SERVICEAL Closure provides the same long-term protection and features of the Ranger SERVICEAL® Closure, in a larger size. Accommodates buried service wire splices up to twelve pairs and cable diameters from 0.4" (10 mm) to 0.6" (15 mm).

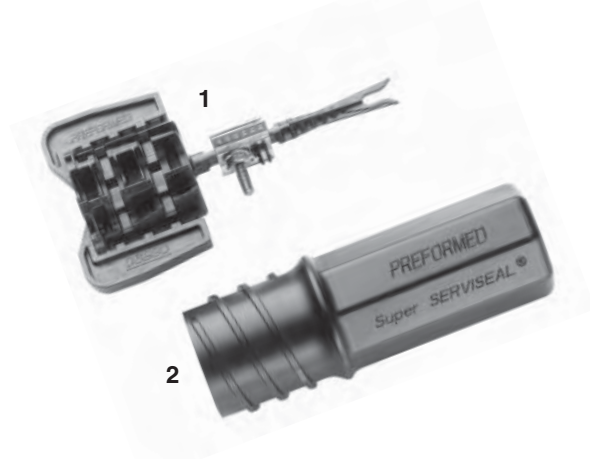

Kit Components

1. Cap with integral Insertion Ram & Bonding Connector
2. Sealant-filled vial

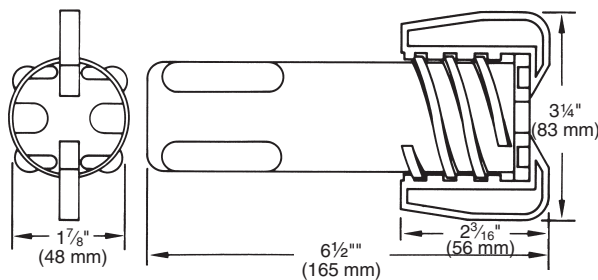

RUS Listed

Catalog Number	Groove Diameter	Standard Carton Qty.
8006039	.4" to Cable (10mm to 15mm)	6 Kits

Catalog Number	Description	Standard Carton Qty.
80851909	Vial Replacement Kit	As needed



BLACK-JACK™ 25/50-Pair Closures

Effectively Protects Cable

The BLACK-JACK 25-Pair and BLACK-JACK™ Plus 50-Pair Closures are filled with POLY-BEE™ Sealant to provide long-term protection for direct buried cable splices (individual or modular connection). The sealant is designed to form a barrier to protect splices against the harsh elements of nature.

The closure designs incorporate a water-block system that consists of a soft cable grommet and a gasket seam seal. The soft grommet is designed to effectively seal around cables within the accepted diameter range. The gasket seals the halves of the closure to further ensure protection.

Two Designs Available

The BLACK-JACK 25-Pair Cable Closure is available in both the traditional butt splice version and the in-line splice version. The 50-pair cable closure is designed to incorporate both butt and in-line capabilities with one design. The in-line version can be used for straight through or branch splice applications. Both designs offer the same reliable service, are easily re-entered and must be replaced after re-entry.

No Resin Required

The one-piece closure shell is shipped with the entire water-block system in place. The unit is pre-filled with POLY-BEE Sealant so there is no resin mixing required.

Without resin, preparation time is greatly reduced. Set-up time is also eliminated. This means the closure can be buried immediately after installation. Working without resin eliminates toxic material concerns and inventory waste because shelf-life is never an issue.

Fast, Easy Application

Several design features make installation easy. The hinge on the shell is flexible allowing the closure to be squeezed shut by hand. The flexible hinge is also helpful during re-entry.

The closing clamp which slides over the closure flanges has a V-notch on the back to make initial hand installation easier. A narrow horizontal slide along the closing clamp provides leverage to bring the halves together. The kit comes with bonding hardware that fits over the studs of the bond connectors to provide shield continuity. This bonding hardware also assures proper alignment of the cables in the closure.

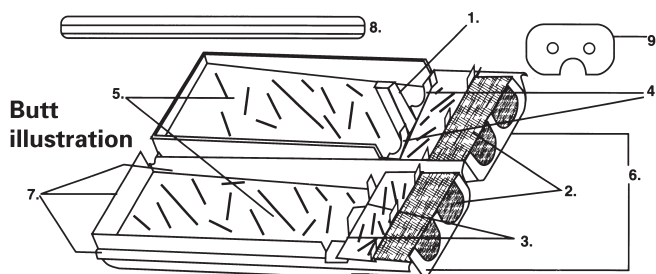

RUS Listed

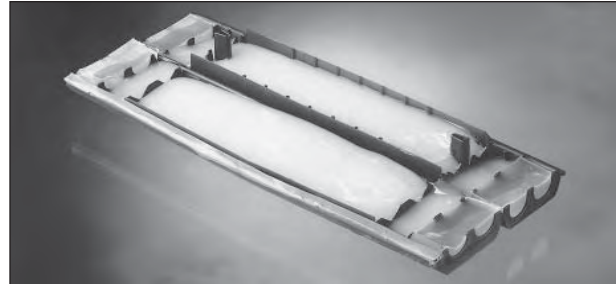

25-Pair In-line Butt Version, Cat. No. 8006508
50-Pair In-Line/Butt Version, Cat. No. 8006681

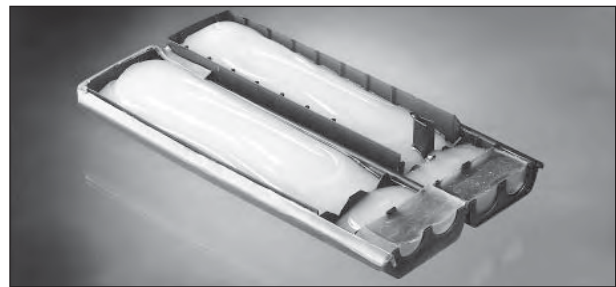

25-Pair Butt Version, Cat. No 8006318

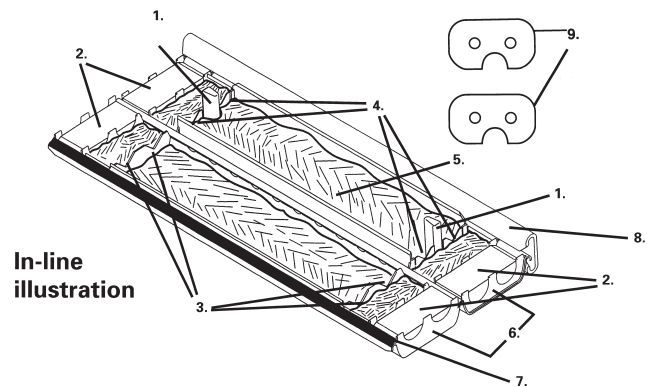

Catalog Number	Description	Measurements
8006508	25-Pair In-Line	16.25"L x 3.5"W x 3"H
8006318	25-Pair Butt	12"L x 3.5"W x 3"H
8006681	50-Pair In-Line	17.5"L x 4.5"W x 4.75"H

Black-Jack Closure Parts:

1. Restraining post(s)
2. Soft grommet(s)
3. Fixed V-notches
4. Hinged V-notch flaps
5. POLY-BEE™ sealant
6. One-piece closure shell
7. Gasket
8. Closing clamp
9. Bonding bridge(s)
10. Gloves (included but not shown)
11. Bonding Links (In-line version only, included but not shown)